

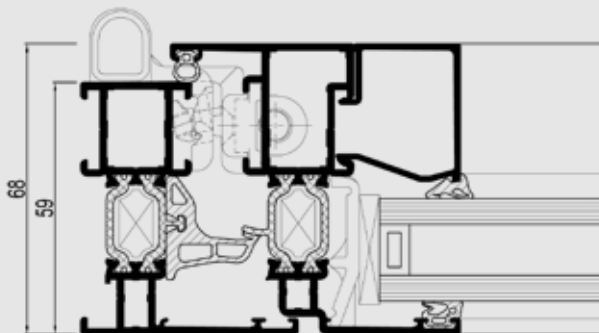

# CS 68

Windows & Doors

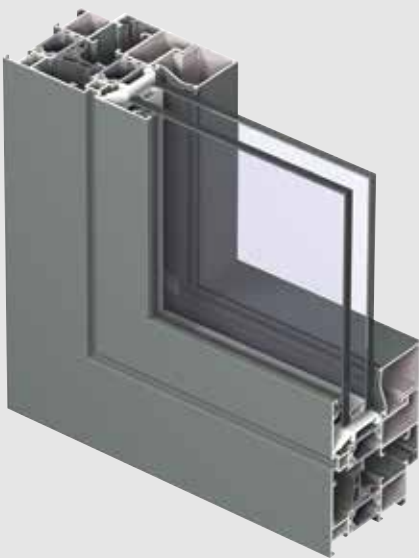

Concept System® 68 is a thermally improved three-chamber system for windows and doors that boasts the optimum combination of high insulation levels and optimal safety.







The system is available in a variety of aesthetic shapes to match current architectural styles whilst offering all types of both inward and outward opening windows and doors. Double butt strips between the frame and vent and lowered drainage ensure superior wind and water tightness.

Different inner and outer colours are possible.

## TECHNICAL CHARACTERISTICS

		
Style variants	FUNCTIONAL	HIDDEN VENT
Min. visible width inward opening window		
Frame	51 mm	76 mm
Vent	33 mm	not visible
Min. visible width outward opening window		
Frame	17,5 mm	-
Vent	76 mm	-
Min. visible width inward opening flush door		
Frame	68 mm	-
Vent	76 mm	-
Min. visible width outward opening flush door		
Frame	42 mm	-
Vent	102 mm	-
Min. visible width T-profile	76 mm	126 mm
Overall system depth window		
Frame	59 mm	59 mm
Vent	68 mm	63.5 mm
Rebate height	25 mm	18,5 mm
Glass thickness	up to 44 mm	up to 44 mm
Glazing method	dry glazing with EPDM or neutral silicones	
Thermal insulation	23 mm omega-shaped fibreglass reinforced polyamide strips	

## PERFORMANCES

ENERGY												
	Thermal Insulation <sup>(1)</sup> EN 10077-2	Uf-value between 1.8 W/m <sup>2</sup> K and 2.9 W/m <sup>2</sup> K, depending on the frame/vent combination										
COMFORT												
	Acoustic performance <sup>(2)</sup> EN ISO 140-3; EN ISO 717-1	Rw (C; Ctr) = 37 (-1; -4) dB / 44 (-2; -5) dB, depending on glazing type										
	Air tightness, max. test pressure <sup>(3)</sup> EN 1026; EN 12207	1 (150 Pa)		2 (300 Pa)		3 (600 Pa)		4 (600 Pa)				
	Water tightness <sup>(4)</sup> EN 1027; EN 12208	2A (50 Pa)	3A (100 Pa)	4A (150 Pa)	5A (200 Pa)	6A (250 Pa)	7A (300 Pa)	8A (450 Pa)	9A (600 Pa)	E750 (750 Pa)	E (1200 Pa)	
	Wind load resistance, max. test pressure <sup>(5)</sup> EN 12211; EN 12210	1 (400 Pa)		2 (800 Pa)		3 (1200 Pa)		4 (1600 Pa)		5 (2000 Pa)		Exxx (> 2000 Pa)
	Wind load resistance to frame deflection <sup>(5)</sup> EN 12211; EN 12210	A (≤ 1/150)			B (≤ 1/200)			C (≤ 1/300)				
SAFETY												
	Burglar resistance <sup>(6)</sup> ENV 1627 - ENV 1630	WK 1			WK 2 (windows & doors)				WK 3 (flush doors)			

This table shows classes and values of performances, which can be achieved for specific configurations and opening types.

- The Uf-value measures the heat flow. The lower the Uf-value, the better the thermal insulation of the frame.
- The sound reduction index (Rw) measures the capacity of the sound reduction performance of the frame.
- The air tightness test measures the volume of air that would pass through a closed window at a certain air pressure.
- The water tightness testing involves applying a uniform water spray at increasing air pressure until water penetrates the window.
- The wind load resistance is a measure of the profile's structural strength and is tested by applying increasing levels of air pressure to simulate the wind force. There are up to five levels of wind resistance (1 to 5) and three deflection classes (A,B,C). The higher the number, the better the performance.
- The burglar resistance is tested by static and dynamic loads, as well as by simulated attempts to break in using specified tools.