

CW 86

High execution speed

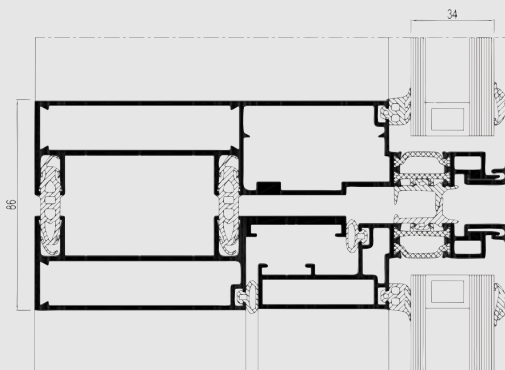
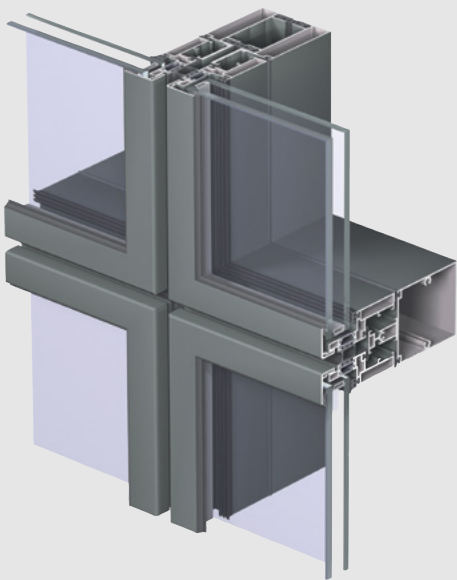

CW 86 enables cassette façades to be built using a traditional stick structure (CW 86). It also enables unitised façades (CW 86-EF) to be completely pre-assembled in the workshop that results in a high execution speed on the building site.

CW 86 is available in Structural Glazing (SG) and Cassette Glazing (CG). The system enables the motorisation of opening elements such as top hung or parallel opening windows. Different types of windows, doors, sliding systems and brise soleil can be integrated.

Different inner and outer colours are possible.





CW 86

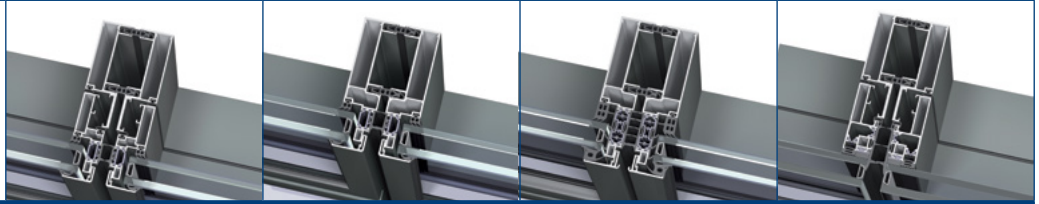





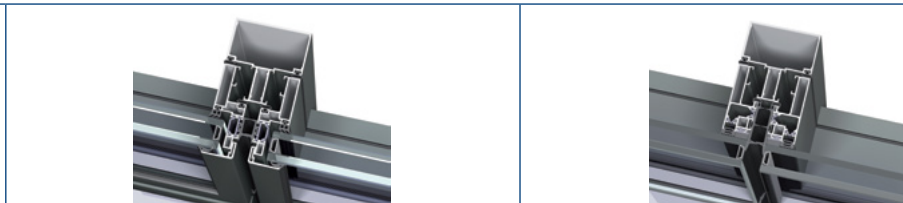

TECHNICAL CHARACTERISTICS - ELEMENT FAÇADE

Style variants	CW 86-EF-CG	CW 86-EF-CG (FIXED FAÇADE JUNIOR)	CW 86-EF-HI	CW 86-EF-SG
	functional	moderate solution	ultimate thermal comfort	structural sealed glazing
Interior visible width	86 mm (38.5 - 9 - 38.5)	86 mm (38.5 - 9 - 38.5)	86 mm (38.5 - 9 - 38.5)	86 mm (38.5 - 9 - 38.5)
Depth vertical mullions	195 mm (fixed element)	150 mm	168 mm	206 mm
Depth horizontal transoms	195 mm (fixed element)	150 mm	168 mm	205.5 mm
Inertia mullions (Ix: wind load)	min. 114.8 cm ⁴ (x2) to max. 243.72 cm ⁴ (x2)	115.7 cm ⁴ (x2)	112.1 cm ⁴	114.7 cm ⁴ (x2)
Inertia transoms (Ix: wind load)	up to max 435.83 cm ⁴	up to max 195.6 cm ⁴	194.7 cm ⁴	up to max 187.11 cm ⁴
Inertia transoms (Iy: glass load)	51.5 cm ⁴ to max 153.38 cm ⁴	116.2 cm ⁴	116.2 cm ⁴	51.54 cm ⁴ to max 99.41 cm ⁴
Exterior visible width	68 mm (26 - 16 - 26) or 86 mm (35 - 16 - 36)	86 mm (35 - 16 - 35)	86 mm (38.5 - 9 - 38.5)	22 mm joint between glass
Exterior aesthetics	aluminium glazing beads	aluminium glazing beads	aluminium glazing beads	glass wall
Glazing	glazing bead + EPDM gasket	glazing bead + EPDM gasket	glazing beads + EPDM gasket	structural glazing on cassettes
Rebate height	19 mm to 21 mm	19 mm to 21 mm	19 mm	32 mm
Glass thickness	from 4 mm to 38 mm	from 6 mm to 38 mm	from 30 up to 50 mm	from 4 mm to 36 mm
Type of vents	integrated top hung window, POW and escape window open out, all types of CS window and door elements	top hung window and POW, all types of CS window and door elements	top hung window and POW, all types of CS window and door elements	integrated top hung window, POW and escape window open out



TECHNICAL CHARACTERISTICS - SEMI ELEMENT FAÇADE

Style variants	CW 86-CG	CW 86-SG
	functional	structural sealed glazing
Interior visible width	86 mm	86 mm
Depth vertical mullions	from 47.5 mm to 161 mm	from 47.5 mm to 161 mm
Depth horizontal transoms	from 47.5 mm to 161 mm	from 47.5 mm to 161 mm
Inertia mullions (Ix: wind load)	min 13.85 cm ⁴ to max 544.25 cm ⁴	min 13.85 cm ⁴ to max 544.25 cm ⁴
Inertia transoms (Ix: wind load)	min 13.85 cm ⁴ to max 544.25 cm ⁴	min 13.85 cm ⁴ to max 544.25 cm ⁴
Inertia transoms (Iy: glass load)	min 18.67 cm ⁴ to max 174.4 cm ⁴	min 18.67 cm ⁴ to max 174.4 cm ⁴
Exterior visible width	68 mm (28 - 16 - 28) or 86 mm (35 - 16 - 35)	22 mm joint between glass
Exterior aesthetics	aluminium glazing beads	glass wall
Glazing	glazing bead + EPDM gasket	structural glazing on cassettes
Rebate height	19 mm to 21 mm	32 mm
Glass thickness	from 4 mm to 38 mm	from 4 mm to 36 mm
Type of vents	integrated top hung window, POW and escape window open out, all types of CS window and door elements	integrated top hung window, POW and escape window open out

PERFORMANCES							
ENERGY							
	Thermal Insulation ⁽¹⁾ EN 13947	Uf ≥ 1.5 W/m ² K, depending on the profile combination.					
COMFORT							
	Acoustic performance ⁽²⁾ EN ISO 140-3; EN ISO 717-1	Rw (C; Ctr) = 41 (-2; -5) dB, other values depending on glazing type					
	Air permeability, max. test pressure ⁽³⁾ EN 12153, EN 12152	A4 (600 Pa)					
	Water tightness ⁽⁴⁾ EN 12155, EN 12154	R4 150	R5 300	R6 450	R7 600	RE 900	RE 1050
	Wind load resistance, max. test pressure ⁽⁵⁾ EN 12179, EN 13116	2000 Pa					
	Impact resistance EN 14019	class I5 / E5					

This table shows possible classes and values of performances. The values indicated in red are the ones relevant to this system.

- (1) The Uf-value measures the heat flow. The lower the Uf-value, the better the thermal insulation of the frame.
- (2) The sound reduction index (Rw) measures the capacity of the sound reduction performance of the frame.
- (3) The air tightness test measures the volume of air that would pass through a closed window at a certain air pressure.
- (4) The water tightness testing involves applying a uniform water spray at increasing air pressure until water penetrates the window.
- (5) The wind load resistance is a measure of the profile's structural strength and is tested by applying increasing levels of air pressure to simulate the wind force. There are up to five levels of wind resistance (1 to 5) and three deflection classes (A,B,C). The higher the number, the better the performance.

